

Welcome to ARI



ARI-Armaturen Albert Richter GmbH & Co. KG



App for communication with the electric actuator ARI-PREMIO-Plus2G



- Remote control
- Parameterization of special functions
- Diagnostic functions
 - Get status information
 - statistics
 - Event logs
 - Trends
 - Histograms
- Service support



myPREMIO

requirements

- **PREMIO-Plus2G**
with actuator firmware **SW 3.5.0 or higher**
- **Communication package option**
including:
 - BT-modul
 - LED-Status Indicator (i.a. to display a BT connection)
 - Analog output 4-20mA / 0-10V
- **Smartphone**
 - Android version: 6 or higher
 - iOS version 10.0 or higher
- **Tablet**
 - iOS version 10.0 or higher

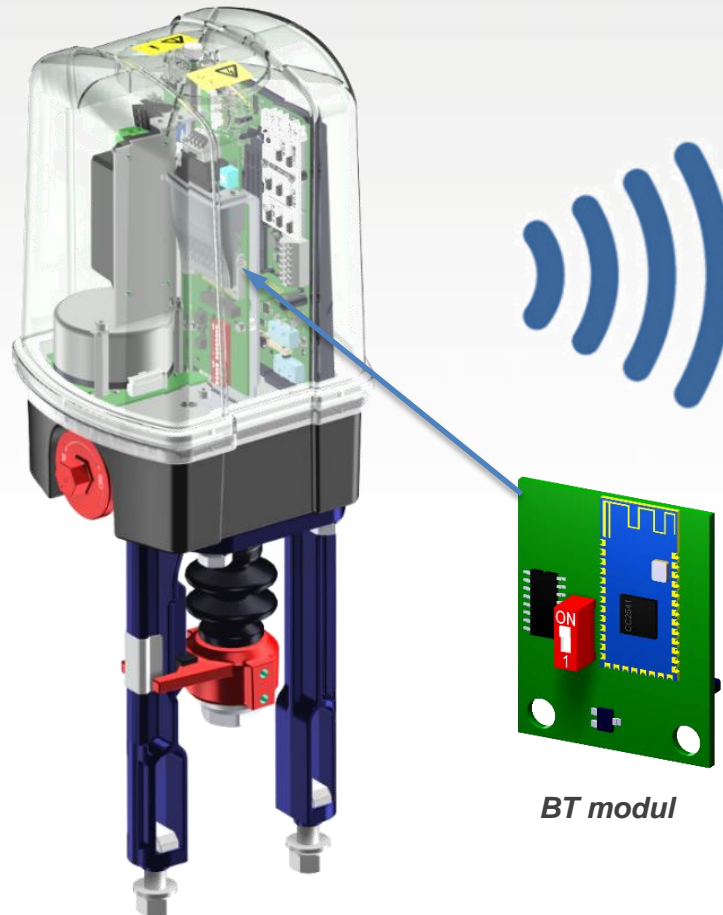

BT modul



myPREMIO

Where can you download the APP?

- The app is offered free of charge via the Apple Store or Google Play Store.



- The corresponding actuators have a sticker on the cover with a QR code.
- The QR code leads to the Apple - or Google Play Store.
- Optionally, the app is also indirectly linked via the ARI homepage.
<https://www.ari-armaturen.com/service/download/mypremio/>

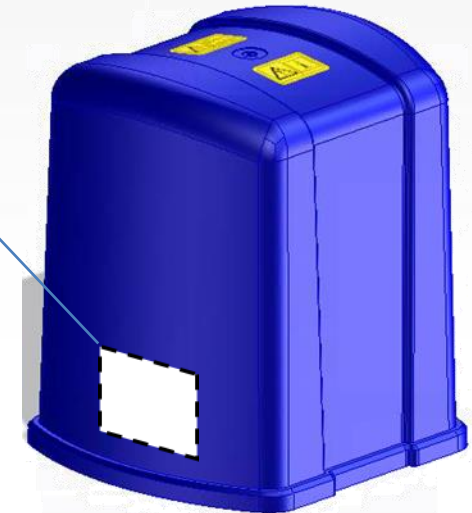
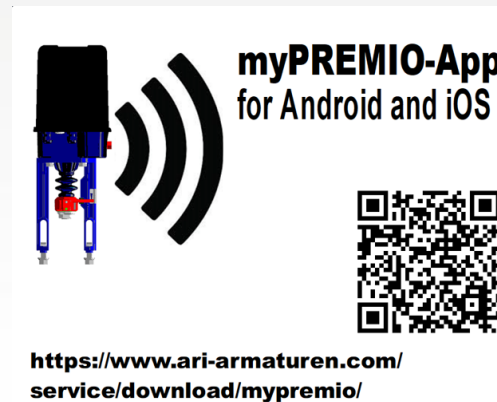

myPREMIO

Structure of the APP

The three main areas of the APP

- **Control functions for the actuator**
only after registration with control rights!
 - Automatic - manual operation
 - UP-STOP-DOWN
 - Exact position entry
 - Start of the initialization run
- **Diagnostic functions**
 - Reading out data and error messages
 - Setting software functions - *only after registration with write rights!*
 - Statistics - trends - event logs
- **Data exchange**
 - Sending the actuator data to ARI customer service for analysis and support in the event of a fault
 - Documents and information
 - Login to the actuator for write or control rights

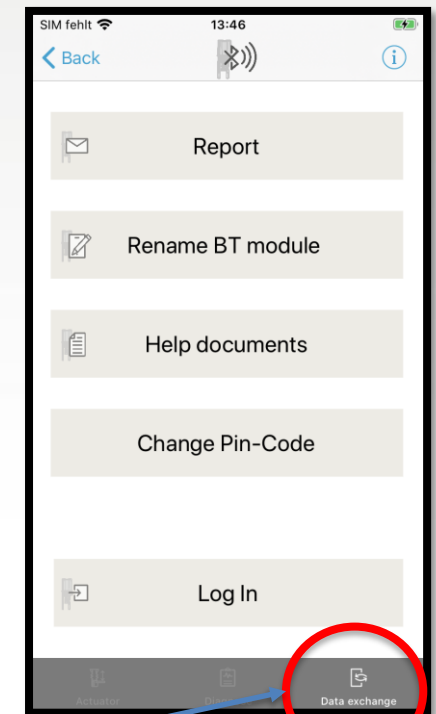
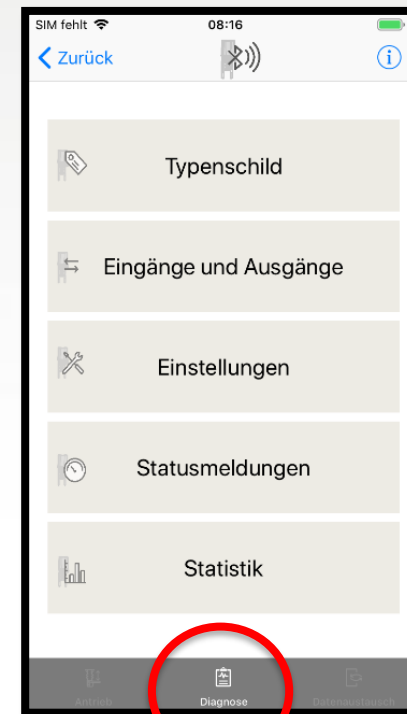
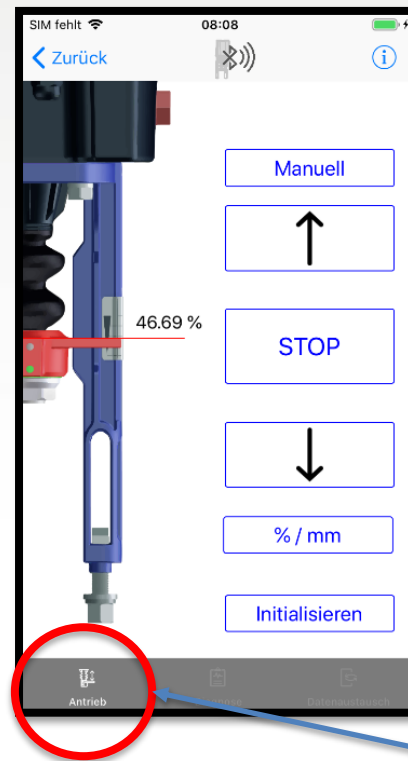

Click here to switch between the main areas!

Benefits - Summary



The communication package:

- ▶ LED status display → on the outside of the actuator shows the current operating status in various colors from green to red
- ▶ Integrated analog feedback signal variably adjustable via app and software if required
- ▶ BT interface as the basis for using the app

The "myPREMO" app:

- ▶ Demo mode → offers the possibility to familiarize yourself with all functions offline. Also ideal for presentations, training courses or simply "study by trying"
- ▶ Status message → Clear text display of error messages and possible solutions
- ▶ Event log → provides a chronological sequence of settings, changes, messages, etc.
- ▶ Diagnostic data → Trend analysis and histogram allow statements on the control behavior and selection of the valve.
- ▶ Data exchange → enables fast and uncomplicated remote diagnosis by the ARI experts
- ▶ Write rights offer further options such as Setting special functions or remote control.

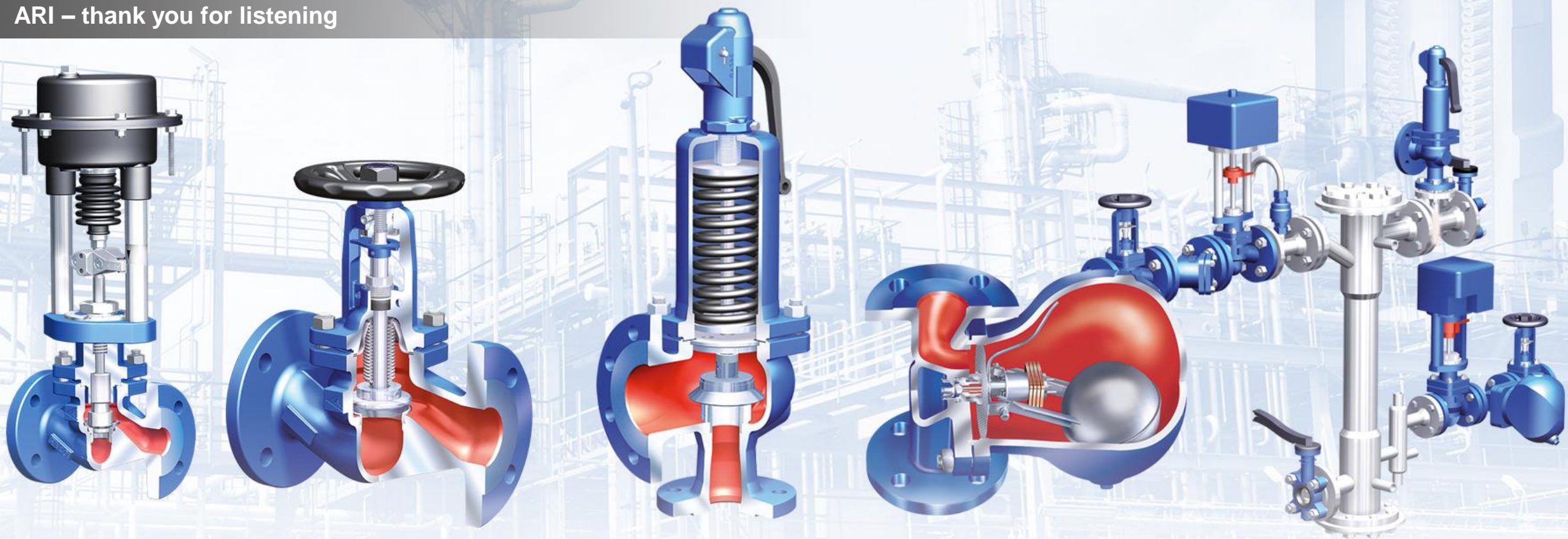

Your one-stop shop for control, isolation, safety, steam trapping and system business

Don't hesitate to ask for advice.
We'd be delighted to help you in
any way we can!

- ▶ www.ari-armaturen.com
- ▶ info.sales@ari-armaturen.com
- ▶ +49 5207 994-0